

Description

The DFMSD15C is a 15V bi-directional TVS diode, utilizing leading monolithic silicon technology to provide fast response time and low ESD clamping voltage, making this device an ideal solution for protecting voltage sensitive data and power line. The DFMSD15C complies with the IEC 61000-4-2 (ESD) standard with ± 30 kV air and ± 30 kV contact discharge. It is assembled into an ultra-small lead-free SOD-323 package. The small size and high ESD surge protection make DFMSD15C an ideal choice to protect cell phone, digital cameras, audio players and many other portable applications.

Mechanical Characteristics

- ◆ Package: SOD-323
- ◆ Case Material: "Green" Molding Compound.
- ◆ Moisture Sensitivity: Level 3 per J-STD-020
- ◆ Terminal Connections: See Diagram Below
- ◆ Marking Information: See Below

Dimensions and Pin Configuration

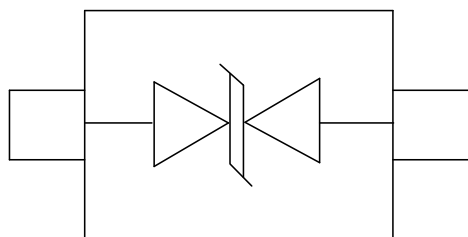

Circuit and Pin Schematic

Features

- ◆ 300W peak pulse power (8/20 μ s)
- ◆ Protects one data or power line
- ◆ Ultra low leakage: nA level
- ◆ Operating voltage: 15V
- ◆ Low clamping voltage
- ◆ 2-pin leadless package
- ◆ Complies with following standards:
 - IEC 61000-4-2 (ESD) immunity test
Air discharge: ± 30 kV
Contact discharge: ± 30 kV
 - IEC61000-4-5 (Lightning) 10A (8/20 μ s)
- ◆ RoHS Compliant

Applications

- ◆ Cellular Handsets and Accessories
- ◆ Personal Digital Assistants
- ◆ Notebooks and Handhelds
- ◆ Portable Instrumentation
- ◆ Peripherals
- ◆ Digital Cameras
- ◆ Audio Players

Marking Information

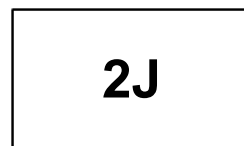

2J=DeviceMarking Code

Ordering Information

Part Number	Marking	Packaging	Reel Size
DFMSD15C	2J	3000/Tape & Reel	7 inch

Absolute Maximum Ratings ($T_A=25^\circ\text{C}$ unless otherwise specified)

Parameter	Symbol	Value	Unit
Peak Pulse Power (8/20 μs)	Ppk	300	W
Peak Pulse Current (8/20 μs)	Ipp	10	A
ESD per IEC 61000-4-2 (Air)	VESD	± 30	kV
ESD per IEC 61000-4-2 (Contact)		± 30	
Operating Temperature Range	TJ	-55 to +125	$^\circ\text{C}$
Storage Temperature Range	Tstg	-55 to +150	$^\circ\text{C}$

Electrical Characteristics ($T_A=25^\circ\text{C}$ unless otherwise specified)

Parameter	Symbol	Min	Typ	Max	Unit	Test Condition
Reverse Working Voltage	VRWM			15	V	
Breakdown Voltage	VBR	16.7			V	IT = 1mA
Reverse Leakage Current	IR			0.5	μA	VRWM = 15V
Clamping Voltage	VC			20	V	I _{PP} = 1A (8 x 20 μs pulse)
Clamping Voltage	VC			30	V	I _{PP} = 10A (8 x 20 μs pulse)
Junction Capacitance	CJ		30		pF	VR = 0V, f = 1MHz

Typical Performance Characteristics (TA=25°C unless otherwise Specified)

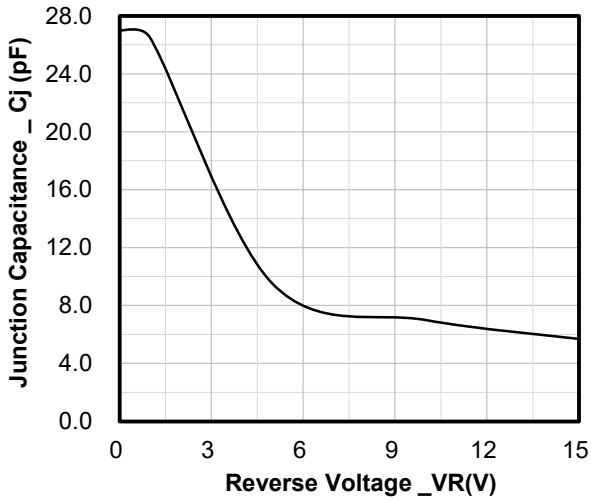

Junction Capacitance vs. Reverse Voltage

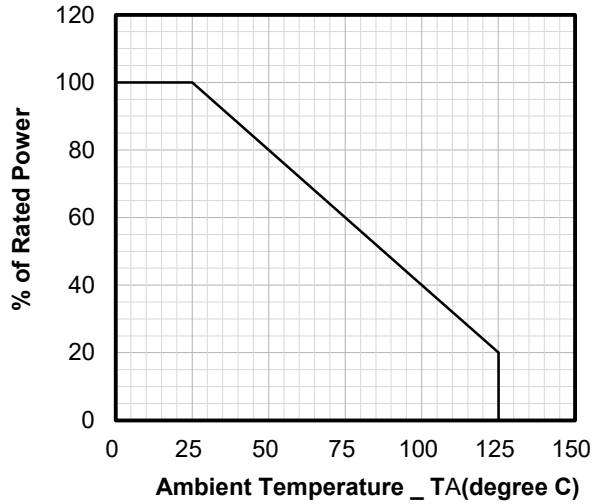

Power Derating Curve

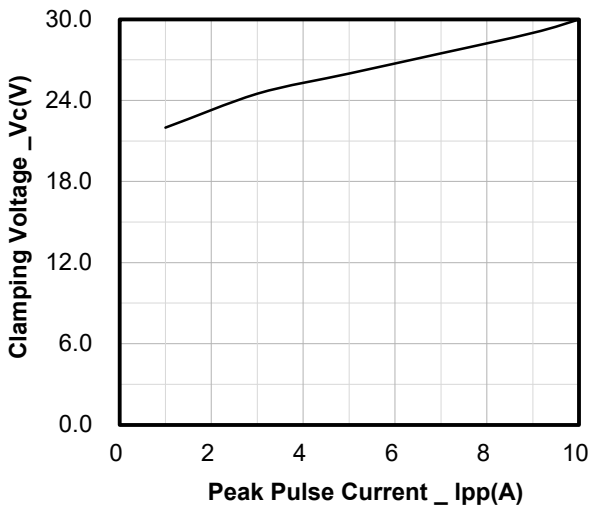

Clamping Voltage vs. Peak Pulse Current

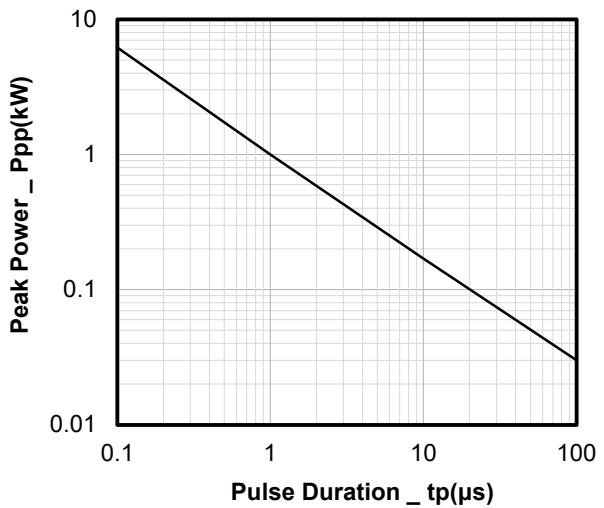

Peak Pulse Power vs. Pulse Time

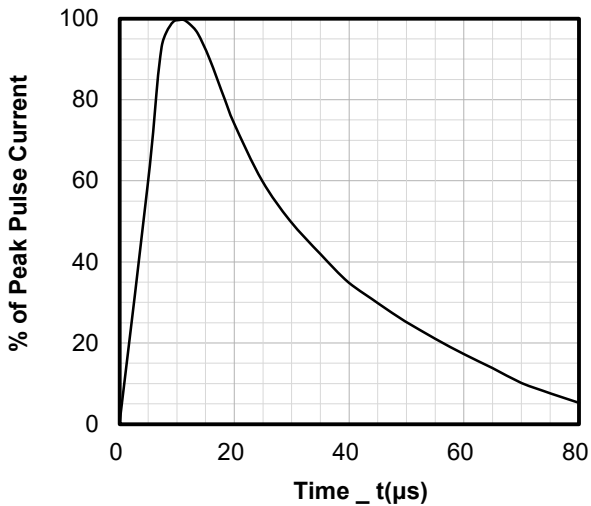

8 X 20μs Pulse Waveform

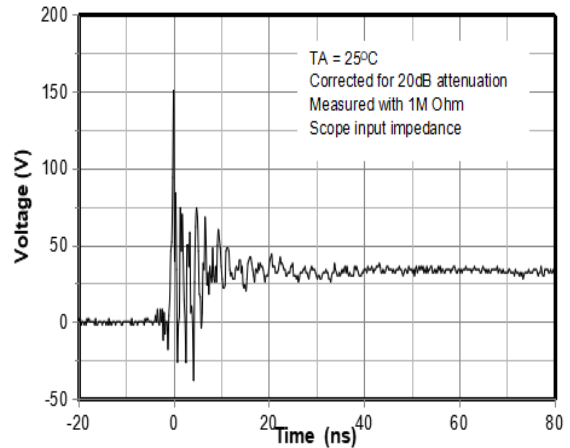

ESD Clamping Voltage

8 kV Contact per IEC61000-4-2

SOD-323 Package Outline Drawing

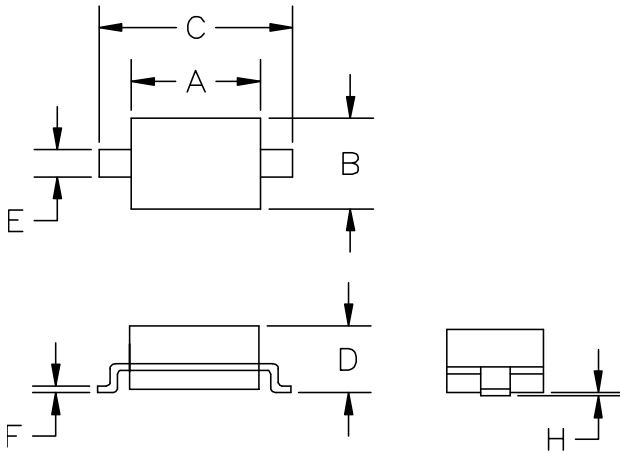

SYM	DIMENSIO			
	MILLIMETERS		INCHES	
	MIN	MAX	MIN	MAX
A	1.50	1.80	0.060	0.071
B	1.20	1.40	0.045	0.054
C	2.30	2.70	0.090	0.107
D	-	1.10	-	0.043
E	0.30	0.40	0.012	0.016
F	0.10	0.25	0.004	0.010
H	-	0.10	-	0.004

Suggested Land Pattern

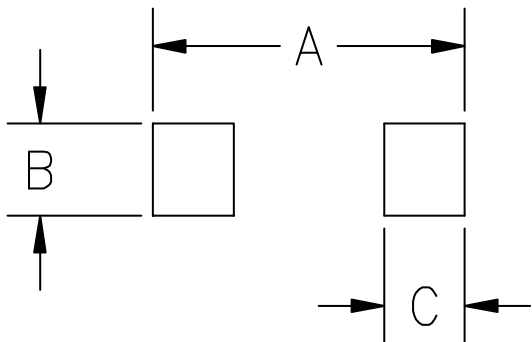

SYM	DIMENSIONS	
	MILLIMETERS	INCHES
A	3.15	0.120
B	0.80	0.031
C	0.80	0.031

Contact Information

Changzhou D-first Electronics CO.,Ltd.

www.first-electronic.com

Email: xhf@first-electronic.cn

Phone: +86 (0519) 8817 1671